

INTERTRON 108 SOFT TOUCH HOOKUP

Connect wires from the SOFT TOUCH cable to the INTERTRON MODEL 108 CONTROL as shown below. The original solenoid valve will not be used with this SOFT TOUCH system.

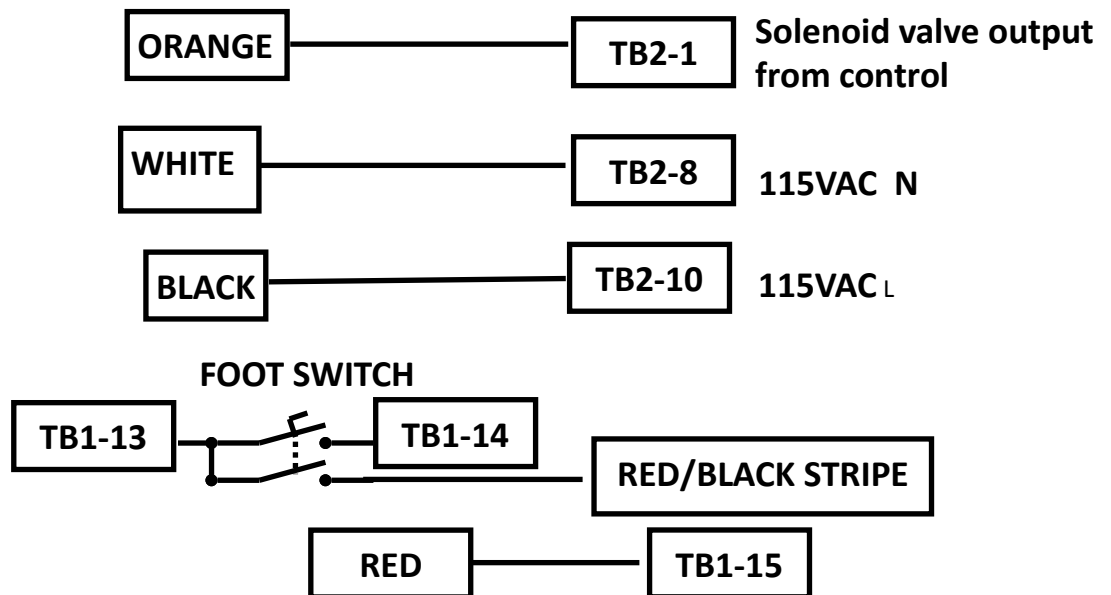

If a jumper is between TB14 and TB15, remove it before connecting the RED wire to TB1-15.

NOTE: If only a single-stage foot switch is being used, connect the RED/BLACK STRIPE wire to TB1-13.

